

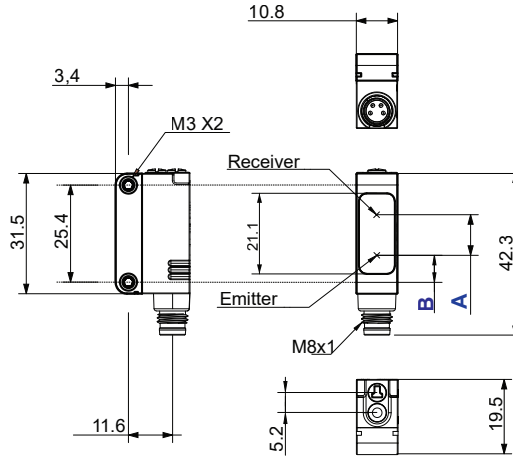

DIMENSIONS

NOTE: "A" and "B" values in the following drawing are indicated in the "Optical Interaxes" table.



| Optical Interaxes | | |
|-------------------|-----|-----|
| Version | A | B |
| S3N-PR-X-Wx3 | 7.2 | 7.5 |

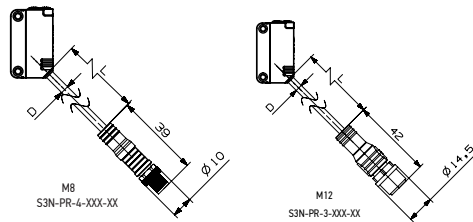

| Version | Pig-tail type | L [mm] | D [mm] |
|-----------------|---------------|--------|--------|
| S3N-PR-3-XXX-XX | M12 – 4p | 250 | 3.7 |
| S3N-PR-4-XXX-XX | M8 – 4p | 200 | 3.7 |

Datasensing S.r.l.
 Strada S. Caterina 235 - 41122 Modena - Italy
 Tel. +39 059 420411 - Fax +39 059 253973
 web: www.datasensing.com
 email: info@datasensing.com

S3N-PR...Wx3
CONTRAST SENSOR

Safety Precautions

Read the precautions for all models at <http://www.datasensing.com>.

- WARNING: This product is not designed or rated to ensure personal safety either directly or indirectly. Do not use it for such purposes.
- WARNING: Do not exceed the rated voltage. There is a possibility of failure and fire.
- CAUTION: Do not use this product above its IP protection ratings. Failing to do so may damage its components.
- CAUTION: DC models shall never be used with AC mains power supply. Failing to do so may result in explosions or other damage.
- CAUTION: Do not disassemble this product. Doing so may cause exposure to the built-in light source which can damage eyes and skin. Never disassemble it.

GENERAL CONTROLS

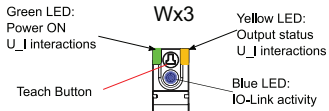

Teach Button (Wx3)

Performs all User interface interactions.

Output LED

The yellow LED indicates the output status.

Power On LED (Wx3)

The green LED indicates that the sensor is operating.

IO-Link Activity LED (Wx3)

The Blue light is on during IO-Link data exchange.

CONNECTIONS

Wx3

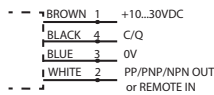

M8 CONNECTOR



M12 CONNECTOR

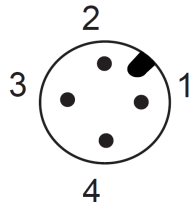

INSTALLATION

The sensor can be positioned by mean of the two threaded holes (M3) using two screws (M3x12 or longer, or M2.5 passing screw + nuts) and relative washers. Maximum tightening torque is 0.5Nm. Various brackets are available to ease the sensor positioning (please refer also to accessories listed in the catalogue).

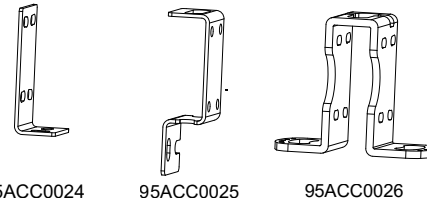

TECHNICAL DATA

| 3N-PR-W03-OZ | |
|--------------------------|---|
| Power Supply: | 10-30 Vdc; reverse polarity protected |
| Ripple: | p-p 10% max. |
| Current consumption: | ≤40mA (≤20mA @24V) |
| Output: | W03: IO-Link (Pin 4) + configurable I/O (Pin 2) |
| Output current: | 100 mA max. short circuit protected |
| Saturation voltage: | 1 V max. |
| Response time: | 16µs/10.5µs selectable min. response at max fsw: 8µs by IO-Link parametrization |
| Jitter: | 8µs/4µs (default: 4µs) |
| Max switching frequency: | 30kHz/60kHz selectable (default: 60kHz) by IO-Link parametrization |
| Indicators: | Yellow: output status Green: power on Blue: IO-Link activity |
| Setting: | Teach button or IO-Link |
| Operating Temperature: | -25°C...55°C (not condensing) |
| Storage Temperature: | -40 ... +70 °C |
| Operating distance: | 12mm |
| Depth of field: | ± 3mm |
| Emission Type: | blue (460nm) / green (525nm) / red (633nm) EC 62471 EXEMPT RISK GROUP (RG0) |
| Ambient light rejection: | According to 60947-5-2 |
| Vibration: | 0.5 mm amplitude, 10 ... 55 Hz frequency, for each axis (EN60068-2-6) |
| Shock resistance: | 11 ms (30 G) 6 shock for each axis (EN60068-2-27) |
| Housing: | Body: Glass filled technopolymer Indicators: TPE Actuators: POM |
| Lenses: | PMMA |
| Protection class: | IP67 |
| Connections: | On S3N-PR-3-xxxxx cable with M12 4-poles connector On S3N-PR-4-xxxxx cable with M8 4-poles connector On S3N-PR-5-xxxxx M8 connector 4 poles |
| Weight: | 50 g. max. cable versions / 10 g. connector versions |

WX3 SETTINGS

S3N-PR-X-Wx3-XX

MARK-BACKGROUND ACQUISITION

Position the mark in front of the sensor light spot and press the SET push-button for 1s until green READY LED turns off, or use IO-Link Standard command "Teach Static (75)". The sensor detects the mark alternating the red, green and blue emissions. Avoid mark movements during this phase.

Position the background in front of the sensor light spot and press the SET push-button again, or use IO-Link Standard command "Teach Static (75)". The sensor detects the mark alternating the red, green and blue emissions. Avoid background movements during this phase.

If the acquisition has been successful, the sensor returns to normal operation. If it has failed due to insufficient contrast the READY LED blinks quickly.

The sensor returns to the previous setting by pressing the push-button, or using IO-Link Standard command "Teach Cancel (79)".

DYNAMIC ACQUISITION

Use dynamic acquisition to acquire moving marks. The sensor detects the contrast between the mark and the moving background, and automatically sets the threshold value. Place the sensor spot in front of the target to be detected. Press the SET button until the READY LED lights up again (3 s) or send the IO-Link Standard command "Teach Dynamic (76)". To end the dynamic acquisition press the SET button or send the IO-Link Standard command "Teach Dynamic (76)". The sensor functions alternating red, green and blue emissions.

If the acquisition has been successful, the sensor returns to normal operation. If it has failed due to insufficient contrast, the READY LED blinks quickly.

The sensor returns to the previous setting by pressing the push-button, or using IO-Link Standard command "Teach Cancel (79)".

WHITE WIRE (PIN2) FUNCTIONS

Pin2 is configured as push-pull output by default. Its configuration is defined by IO-Link parameter "Output type (180) - subidx2".

If configured as INPUT, the input function is settable by "Input Function Configuration (91)".

The available functions are: REMOTE, L/D and DELAY ENABLE.

When pin2 is configured as input and an input function is assigned to it, the input function overwrites the corresponding IO-Link parameter. For example, if pin2 is configured as delay enable input, the IO-Link parameter "Delay mode (72 - subidx 1)" will always copy the state of pin2."

LIGHT/DARK INPUT

In LIGHT mode, the output is active with light marks on dark backgrounds.

In DARK mode, the output is active with dark marks on light backgrounds.

The connection of the DARK/LIGHT wire to Vcc sets the LIGHT mode. If connected to or not connected, it sets the DARK mode.

| DARK/LIGHT | Mode |
|------------|-------|
| +Vcc | LIGHT |
| 0V | DARK |

REMOTE INPUT

The REMOTE signal can perform the acquisition functions without using the SET pushbutton. Select pin 2 or 5 through IO-Link. The REMOTE wire connected to +Vcc is equal to pressing the SET push-button. If it is connected to GND or not connected, it is equal to not pressing the SET push-button.

| REMOTE | SET push-button |
|--------|-----------------|
| 0V | Not pressed |
| +Vcc | Pressed |

The duration of the REMOTE wire connection to +Vcc determines the acquisition type:

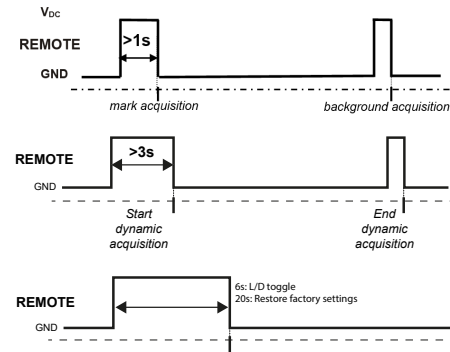

DELAY OFF ENABLE INPUT

The DELAY set through IO-Link extends the minimum duration of the active output allowing slower interfacing systems to detect shorter pulses. The delay value is set by IO-Link parameter "Delay Settings (72) - subidx 2". Default value is 20ms.

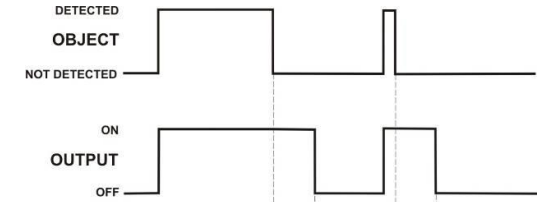

Delay activation

Connect the Delay signal (white wire) to power supply.

Delay deactivation

Connect the Delay signal (white wire) to 0V or leave disconnected.

| DELAY INPUT | Delay mode |
|-------------|------------|
| 0V | No delay |
| +Vcc | Delay off |

TEACH MODE FUNCTIONS

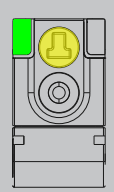
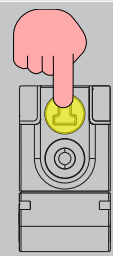
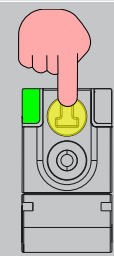
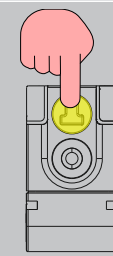
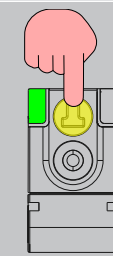
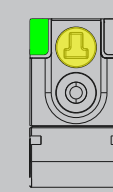
| | Push and hold for... | 1s | 3s | 6s | 20s | Button release |
|-----------------|--|---|--|---|--|--|
| Function | Idle | Static Teach | Dynamic Teach | L/D Select (Toggle) | Restore factory settings | Idle |
| Visual Feedback |  Green LED on |  Green LED off |  Green LED on |  Green LED off |  Green LED on |  Green LED on |

IO-LINK PARAMETERS

To download the IO-Link parameters, click or scan the QR code below.



WHERE TO FIND YOUR PRODUCT MODEL NAME

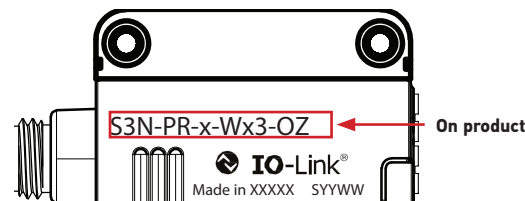

DATASENSING
www.datasensing.com



95B010102



SYYYWW

Made in XXXXX Scan QR Code for web manual

S3N-PR-5-W03-OZ

Contrast IO-Link
POWER SUPPLY: 10...30 VDC LOAD: 100mA
OP. DISTANCE: 12mm ±3mm

TEMP. OP.: -25...+55 °C PROT: IP67

BN 1 → +10...30VDC
BK 4 → C/Q
BU 3 → 0V
WH 2 → PPI/PNP/INP OUT REMOTE IN

  
   
49LF

Pat. See www.patents.datasensing.com for patent list

On bag label →

See www.patents.datasensing.com for patent list.

This product is covered by one or more of the following patents:

Utility patents: IT102015000057325, IT102017000151097, US10823878, US11146425, US11163090.

©2023 Datasensing S.r.l.

• All rights reserved • Without limiting the rights under copyright, no part of this documentation may be reproduced, stored in or introduced into a retrieval system, or transmitted in any form or by any means, or for any purpose, without the express written permission of Datasensing S.r.l. • Datasensing and the Datasensing logo are trademarks of Datasensing S.r.l.



Datasensing S.r.l.
 Strada S. Caterina 235 - 41122 Modena - Italien
 Tel. +39 059 420411 - Fax +39 059 253973
 Web: www.datasensing.com
 email: info@datasensing.com

S3N-PR...Wx3

KONTRASTSENSOR

Sicherheitsvorkehrungen
 Die Sicherheitsvorkehrungen für alle Modelle auf der Seite <http://www.datasensing.com> lesen.

- ACHTUNG:** Dieses Produkt ist weder direkt noch indirekt für die Sicherheit von Personen konzipiert oder ausgelegt. Nicht für solche Zwecke verwenden.
- ACHTUNG:** Die Nennspannung darf nicht überschritten werden. Gefahr von Ausfällen und Bränden.
- WARNUNG:** Dieses Produkt nicht über seiner IP-Einstufung verwenden. Die Nichtbeachtung dieser Sicherheitsvorkehrungen kann zu einer Beschädigung der Bauteile führen.
- WARNUNG:** Gleichstrommodelle dürfen niemals mit Wechselstrom betrieben werden. Andernfalls kann es zu Explosionen oder anderen Schäden kommen.
- WARNUNG:** Das Produkt nicht demontieren. Die Aussetzung gegenüber der eingebauten Lichtquelle kann Augen- und Hautschäden verursachen. Niemals demontieren.

ALLGEMEINE KONTROLLEN

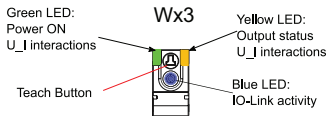

Teach-Taste (Wx3)
 Führt alle Interaktionen der Benutzeroberfläche aus.

Ausgangs-LED
 Die gelbe LED gibt den Status des Ausgangs an.

Power-LED (Wx3)
 Die grüne LED zeigt an, dass der Sensor in Betrieb ist.

ANSCHLÜSSE

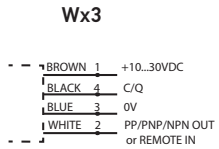

STECKVERBINDER M8



STECKVERBINDER M12

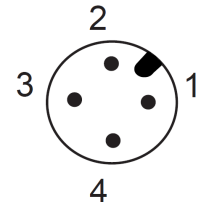

ABMESSUNGEN

HINWEIS: Die Werte „A“ und „B“ in der folgenden Zeichnung sind in der Tabelle „Optikabstand“ angegeben.

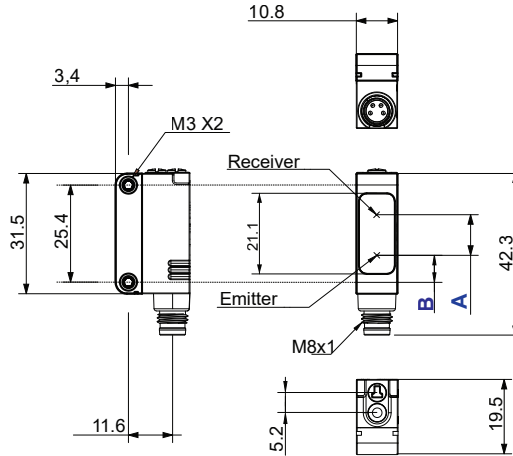

| Optikabstand | | |
|--------------|-----|-----|
| Version | A | B |
| S3N-PR-X-Wx3 | 7,2 | 7,5 |

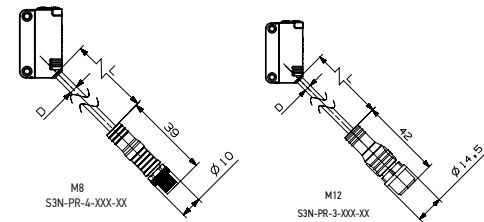

| Version | Typ Pigtail | L [mm] | P [mm] |
|-----------------|-------------|--------|--------|
| S3N-PR-3-XXX-XX | M12- 4 Pole | 250 | 3,7 |
| S3N-PR-4-XXX-XX | M8- 4 Pole | 200 | 3,7 |

INSTALLATION

Der Sensor kann über die beiden Gewindelöcher (M3) mit zwei Schrauben (M3x12 oder länger, oder M2,5 Durchgangsschraube + Muttern) mit den entsprechenden Unterlegscheiben befestigt werden. Das maximale Anzugsdrehmoment beträgt 0,5Nm. Zur einfacheren Positionierung des Sensors sind verschiedene Montagewinkel verfügbar (auch Bezug auf das im Katalog aufgeführte Zubehör nehmen).

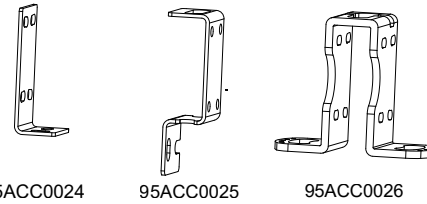

TECHNISCHE DATEN

| 3N-PR-W03-OZ | |
|--------------------------|--|
| Betriebsspannung: | 10-30 Vdc; Verpolungsschutz |
| Welligkeit: | p-p 10 % max. |
| Stromaufnahme: | ≤40 mA (≤20 mA bei 24 V) |
| Ausgang: | W03: IO-Link (Pin 4)+ I/O konfigurierbar (Pin 2) |
| Ausgangsstrom: | max. 100 mA, kurzschlussfest |
| Sättigungsspannung: | max. 1 V |
| Ansprechzeit: | 16 us/10.5 us wählbar min. Ansprechen auf max. Schaltfrequenz 8 us über Parametrisierung IO-Link |
| Jitter: | 8 us/4 us (Default: 4 us) |
| Max. Schaltfrequenz: | 30 kHz/60 kHz wählbar (Default: 60 kHz) über Parametrisierung IO-Link |
| Anzeigen: | Gelb: Status des Ausgangs Grün: eingeschaltet Blau: Aktivität IO-Link |
| Einstellung: | Teach-Taste oder IO-Link |
| Betriebs-temperatur: | -25 °C...55 °C (kondensfrei) |
| Einlagerungs-temperatur: | -40 ... +70 °C |
| Reichweite: | 12 mm |
| Tiefenschärfe: | ± 3 mm |
| Sender, Wellenlänge: | blau (460 nm) / grün (525 nm) / rot (633 nm) IEC 62471 RISIKOGRUPPE (RG0) BEFREIT |
| Umgebungs-helligkeit: | gemäß 60947-5-2 |
| Vibrationen: | Amplitude 0,5 mm, Frequenz 10 ... 55 Hz, für jede Achse (EN60068-2-6) |
| Schockbeständigkeit: | 11 ms (30 G) 6 Schock pro Achse (EN60068-2-27) |
| Gehäuse: | Körper: Glasgefülltes Technopolymer Anzeigen: TPE Stellantriebe: POM |
| Objektive: | PMMA |
| Schutzklasse: | IP67 |
| Anschlüsse: | An Kabel S3N-PR-3-xxxx mit 4-poligem M12 Stecker An Kabel S3N-PR-4-xxxx mit 4-poligem M8 Stecker An S3N-PR-5-xxxx 4-poliger M8 Stecker |
| Gewicht: | 50 g max. Versionen mit Kabel / 10 g. Versionen mit Steckverbinder |

EINSTELLUNGEN WX3

S3N-PR-X-Wx3-XX ⓘ

MARKIERUNGS-/HINTERGRUND-ERFASSUNG

Die Markierung vor dem Lichtspot des Sensors anordnen, dann die Taste EINSTELLEN (SET) 1 Sekunde lang drücken, bis die grüne LED des Status BEREIT (READY) erlischt oder den IO-Link-Standardbefehl „Teach Static (75)“ geben. Der Sensor erfasst die Markierung und sendet abwechselnd rote, grüne und blaue Emissionen. Es vermeiden, die Markierung in dieser Phase zu bewegen. Den Hintergrund vor dem Lichtspot des Sensors anordnen, dann die Taste EINSTELLEN (SET) erneut drücken oder den IO-Link-Standardbefehl „Teach Static (75)“ geben. Der Sensor erfasst die Markierung und sendet abwechselnd rote, grüne und blaue Emissionen. Es vermeiden, den Hintergrund in dieser Phase zu bewegen.





War die Erfassung erfolgreich, schaltet der Sensor in den normalen Betrieb zurück. Ist die Erfassung aufgrund eines unzureichenden Kontrasts fehlgeschlagen, blinkt die LED des Status BEREIT (READY) schnell. Auf das Drücken der Taste oder über den IO-Link-Standardbefehl „Teach Cancel (79)“ bringt sich der Sensor auf seine vorherige Einstellung zurück.

DYNAMISCHE ERFASSUNG

Die dynamische Erfassung verwenden, um sich in Bewegung befindliche Markierungen zu erfassen. Der Sensor erfasst den Kontrast zwischen der Markierung und dem sich in Bewegung befindlichen Hintergrund und stellt automatisch den Schwellenwert ein. Den Spot des Sensors vor dem zu erfassenden Objekt anordnen. Die Taste EINSTELLEN (SET) so lange drücken, bis die LED des Status BEREIT (READY) wieder aufleuchtet (3 Sek.) oder den IO-Link-Standardbefehl „Teach Dynamic (76)“ geben. Um die dynamische Erfassung zu beenden, die Taste EINSTELLEN (SET) drücken oder den IO-Link-Standardbefehl „Teach Dynamic (76)“ geben.

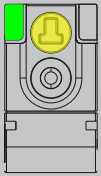
Der Sensor sendet abwechselnd rote, grüne und blaue Emissionen. War die Erfassung erfolgreich, schaltet der Sensor in den normalen Betrieb zurück. Ist die Erfassung aufgrund eines unzureichenden Kontrasts fehlgeschlagen, blinkt die LED des Status BEREIT (READY) schnell. Auf das Drücken der Taste oder über den IO-Link-Standardbefehl „Teach Cancel (79)“ bringt sich der Sensor auf seine vorherige Einstellung zurück.

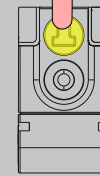
FUNKTIONEN ANLERNMODUS

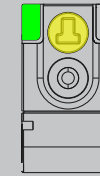
| | Drücken für mindestens... | 1s | 3s | 6s | 20s | Taste loslassen |
|---------------------------|---|---|---|---|---|---|
| Funktionsgruppe | Inaktiv | Statisches Teach | Dynamisches Teach | Wahl Hell/Dunkel (Umschalten) | Die Werkseinstellungen wiederherstellen | Inaktiv |
| Visuelles Feedback |  |  |  |  |  |  |
| | Grüne LED leuchtet | Grüne LED ausgeschaltet | Grüne LED leuchtet | Grüne LED ausgeschaltet | Grüne LED leuchtet | Grüne LED leuchtet |

WO SICH DIE MODELLBEZEICHNUNG IHRES PRODUKTS BEFINDET

PARAMETER IO-LINK

Um die IO-Link-Parameter herunterzuladen, klicken oder den folgenden QR-Code scannen.

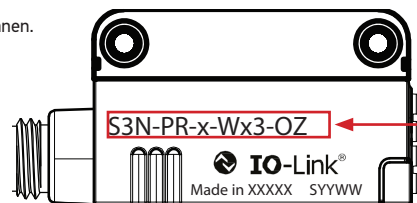

Auf dem Produkt

FUNKTIONEN DES WEISSEN DRAHTS (PIN2)

Der Pin2 ist standardgemäß als „push-pull“-Ausgang konfiguriert. Seine Konfiguration wird vom Parameter IO-Link „Output type (180) - subidx2“ bestimmt.

Ist er als EINGANG konfiguriert, kann die Eingangsfunktion über den Steuerbefehl „Input Function Configuration (91)“ eingestellt werden. Folgende Funktionen stehen zur Verfügung: REMOTE (FERNSTEUERUNG), L/D und FREISCHALTUNG VERZÖGERUNG.

Wurde der Pin2 als Eingang konfiguriert und wird ihm eine Eingangsfunktion zugewiesen, hat er Vorrang vor dem entsprechenden IO-Link-Parameter. Wenn Pin2 beispielsweise als Freigabeeingang der Verzögerung konfiguriert ist, kopiert der IO-Link-Parameter „Delay mode (72 - subidx 1)“ stets den Status von Pin2.

EINGANG HELL/DUNKEL

Im Modus „HELL“ ist der Ausgang bei hellen Markierungen auf dunklem Hintergrund aktiv.

Im Modus „DUNKEL“ ist der Ausgang bei dunklen Markierungen auf hellem Hintergrund aktiv.

Durch Anschluss des Drahts „DUNKEL/HELL“ an Vcc wird der Modus „HELL“ eingestellt. Wenn er angeschlossen oder nicht angeschlossen ist, wird der Modus „HELL“ eingestellt.

| DUNKEL/HELL | Modus |
|-------------|--------|
| +Vdc | HELL |
| 0 V | DUNKEL |

EINGANG REMOTE

Das Signal REMOTE setzt die Erfassungsfunktionen ohne die Taste EINSTELLEN (SET) um. Den Pin 2 oder 5 über IO-Link wählen. Der Draht REMOTE entspricht, wenn an +Vdc geschlossen, dem Drücken der Taste EINSTELLEN (SET). Wenn mit der Masse „GND“ verbunden oder nicht angeschlossen, entspricht dies dem Nichtdrücken der Taste EINSTELLEN (SET).

| REMOTE | Taste EINSTELLEN (SET) |
|--------|------------------------|
| 0 V | Nicht gedrückt |
| +Vdc | Gedrückt |

Die Dauer der Verbindung des Drahts REMOTE mit +Vdc bestimmt die Art der Erfassung:

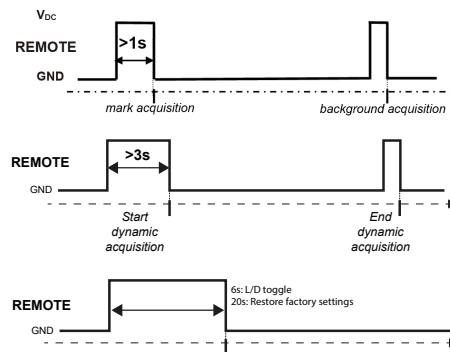

EINGANG FREIGABEVERZÖGERUNG OFF

Die über IO-Link eingestellte VERZÖGERUNG verlängert die Mindestdauer des aktiven Ausgangs, so dass langsamere Schnittstellensysteme kürzere Impulse erfassen können. Der Verzögerungswert wird über den IO-Link-Parameter „Delay Settings (72) - subidx 2“ eingestellt. Der Defaultwert ist 20 ms.

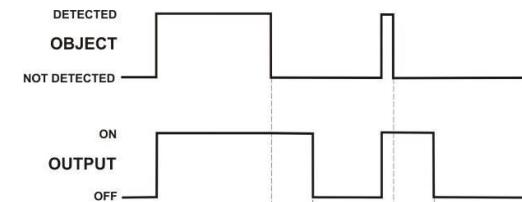

Aktivierung der Verzögerung

Das Verzögerungssignal (weißer Draht) an die Versorgung anschließen.

Deaktivierung der Verzögerung

Das Verzögerungssignal (weißer Draht) an 0V anschließen oder getrennt lassen.

| EINGANG VERZÖGERUNG | Verzögerungsmodus |
|---------------------|-------------------------|
| 0 V | Keine Verzögerung |
| +Vdc | Verzögerung deaktiviert |

Auf dem Etikett des Beutels

DATASENSING
www.datasensing.com

95B010102

Scanned QR Code for web manual

S3N-PR-5-W03-OZ

Contrast IO-Link
POWER SUPPLY: 10...30 VDC LOAD: 100mA
OP. DISTANCE: 12mm ±3mm

TEMP. OP.: -25...+55 °C PROT: IP67

BN 1 → +10...30VDC
BK 4 → C/Q
BU 3 → 0V
WH 2 → PPI/NPN/IN REMOTE IN

IO-Link, UL, CE, UK, CA, LISTED 49LF

Pat. See www.patents.datasensing.com for patent list

Die Liste der Patente ist unter www.patents.datasensing.com verfügbar. Dieses Produkt ist durch eines oder mehrere der folgenden Patente geschützt. Gebrauchspatente: IT102015000057325, IT102017000151097, US10823878, US11146425, US11163090. ©2023 Datasensing S.r.l.

• Alle Rechte vorbehalten • Ohne hierdurch die urheberrechtlich geschützten Rechte einzuschränken, darf kein Teil dieser Dokumentation ohne ausdrückliche schriftliche Zustimmung der Datasensing S.r.l. und/oder ihrer Tochtergesellschaften in irgendeiner Form oder mit einem beliebigen Mittel oder für einen beliebigen Zweck vervielfältigt, gespeichert oder in ein Datenabrufsystem eingegeben bzw. übertragen werden. • Datasensing und das Logo Datasensing logo sind eingetragene Marken von Datasensing S.r.l.



Datasensing S.r.l.
 Strada S. Caterina 235 - 41122 Modène - Italie
 Tél. +39 059 420411 - Fax +39 059 253973
 web: www.datasensing.com
 courriel : info@datasensing.com

S3N-PR...Wx3

CAPTEUR DE CONTRASTE

Avis de sécurité

Les avis de sécurité de chaque modèle se trouvent sur le site <http://www.datasensing.com>.

- ATTENTION** : Ce produit n'est pas conçu ni classé pour garantir la sécurité des personnes, que ce soit directement ou indirectement. Ne l'utilisez pas à de telles fins.
- AVERTISSEMENT** : Ne pas dépasser la tension nominale. Risque de panne et d'incendie.
- AVERTISSEMENT** : Utilisez ce produit dans les limites autorisées par son indice de protection IP et pas au-delà. Autrement, vous risquez d'endommager des composants.
- AVERTISSEMENT** : Les modèles fonctionnant en courant continu ne doivent jamais être branchés sur le secteur qui est en courant alternatif. Le non-respect de cette consigne peut entraîner une explosion ou d'autres dommages.
- AVERTISSEMENT** : Ne pas démonter le produit. L'exposition à la source lumineuse intégrée peut provoquer des lésions oculaires et cutanées. Ne jamais le démonter.

CONTRÔLES GÉNÉRAUX

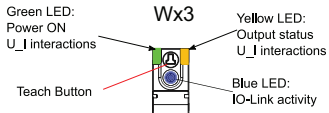

Bouton Teach (Wx3)
 Effectue toutes les interactions de l'interface utilisateur.

LED de sortie
 La LED jaune indique l'état de la sortie.

LED d'allumage (Wx3)
 La LED verte indique que le détecteur est actif.

LED d'activité IO-Link (Wx3)
 La lumière bleue est allumée pendant l'échange de données IO-Link.

RACCORDEMENTS

Wx3

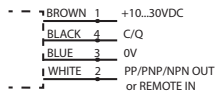

CONNECTEUR M8



CONNECTEUR M12

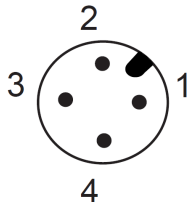

DIMENSIONS

REMARQUE : Les valeurs « A » et « B » du dessin ci-dessous sont indiquées dans le tableau « Entraxes optiques ».

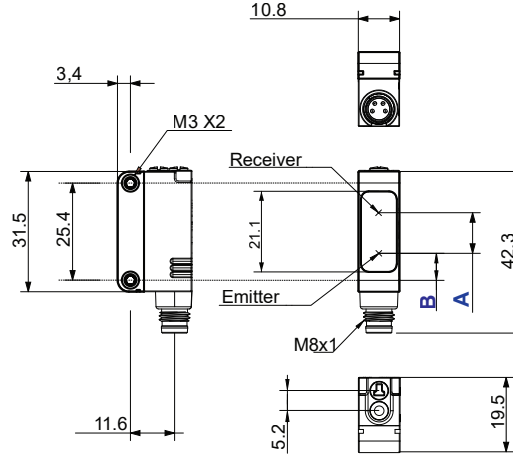

| Entraxes optiques | | |
|-------------------|-----|-----|
| Version | A | B |
| S3N-PR-X-Wx3 | 7,2 | 7,5 |

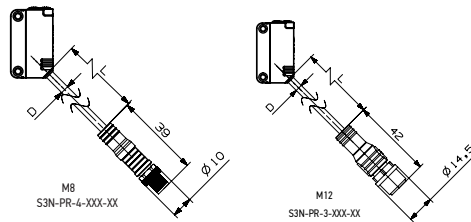

| Version | Type déporté | L [mm] | P [mm] |
|-----------------|--------------|--------|--------|
| S3N-PR-3-XXX-XX | M12 - 4p | 250 | 3,7 |
| S3N-PR-4-XXX-XX | M8 - 4p | 200 | 3,7 |

INSTALLATION

Le détecteur peut être installé au moyen des deux trous filetés (M3) à l'aide des deux vis (M3x12 ou plus longues, ou goujon M2,5 + écrous) et leurs rondelles. Le couple de serrage maximal est de 0,5 Nm.

Des équerres sont disponibles pour faciliter le positionnement du détecteur (se référer également aux accessoires énumérés dans le catalogue).

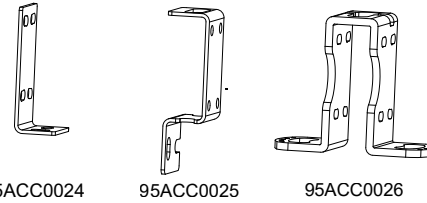

DONNÉES TECHNIQUES

| 3N-PR-W03-OZ | |
|-----------------------------------|---|
| Tension d'alimentation : | 10-30 Vcc ; protection contre les inversions de polarité |
| Tension de ripple : | p-p 10 % max. |
| Consommation de courant : | ≤40mA (≤20mA à 24V) |
| Sortie : | W03 : IO-Link (broche 4)+ E/S configurable (broche 2) |
| Courant de sortie : | 100 mA max., protection contre les courts-circuits |
| Tension de saturation : | 1 V max. |
| Temps de réponse : | 16µs/10.5µs sélectionnable réponse minimale à la fréquence de commutation maximale : 8us via paramétrage IO-Link |
| Jitter : | 8us/4us (par défaut : 4us) |
| Fréquence max. de commutation : | 30kHz/60kHz sélectionnable (par défaut : 60 kHz) via paramétrage IO-Link |
| Indicateurs : | Jaune : état de la sortie Vert : allumage Bleu : Activité IO-Link |
| Configuration : | Bouton Teach ou IO-Link |
| Température de fonctionnement : | -25 °C...55 °C (sans condensation) |
| Température de stockage : | -40 °C...+70 °C |
| Portée opérationnelle : | 12 mm |
| Profondeur de champ : | ± 3 mm |
| Type d'émission : | bleu (460nm) / vert (525nm) / rouge (633nm) IEC 62471 GROUPE DE RISQUE EXEMPT (RGD) |
| Réjection à la lumière ambiante : | Selon 60947-5-2 |
| Vibrations : | amplitude 0.5 mm, fréquence 10 ... 55 Hz, pour chaque axe (EN60068-2-6) |
| Résistance aux chocs : | 11 ms (30 G) 6 chocs pour chaque axe (EN60068-2-27) |
| Conteneur : | Corps : Technopolymère chargé de verre Indicateurs : TPE Actionneurs : POM |
| Lentilles : | PMMA |
| Indice de protection : | IP67 |
| Connexions : | Sur le câble S3N-PR-3-xxxxx avec connecteur M12 à 4 pôles Sur le câble S3N-PR-4-xxxxx avec connecteur M8 à 4 pôles Sur S3N-PR-5-xxxxx : connecteur M8 à 4 pôles |
| Poids : | 50 g max. versions à câble / 10 g. versions à connecteur |

CONFIGURATIONS WX3

S3N-PR-X-Wx3-XX ⓘ

SAISIE REPÈRE/ARRIÈRE-PLAN

Positionner le repère devant le spot lumineux du capteur et appuyer sur le bouton CONFIGURER pendant 1s jusqu'à l'extinction de la LED verte d'état PRÊT ou utiliser la commande standard IO-Link « Teach Static (75) ». Le capteur détecte le repère par alternance d'émissions de couleur rouge, verte et bleue. Éviter de déplacer le repère pendant cette phase.

Positionner l'arrière-plan devant le spot lumineux du capteur et appuyer de nouveau sur le bouton CONFIGURER ou utiliser la commande IO-Link Standard « Teach Static (75) ». Le capteur détecte le repère par alternance d'émissions de couleur rouge, verte et bleue. Éviter de déplacer l'arrière-plan pendant cette phase.

Si la saisie a réussi, le capteur revient au mode de fonctionnement normal. Si la saisie a échoué à cause d'un contraste insuffisant, la LED d'état PRÊT clignote de manière rapide.

En appuyant sur le bouton ou en utilisant la commande IO-Link Standard « Teach Cancel (79) », le capteur revient à la configuration précédente.

SAISIE DYNAMIQUE

Utiliser la saisie dynamique pour acquérir les repères en mouvement. Le capteur détecte le contraste entre le repère et l'arrière-plan en mouvement et définit automatiquement la valeur de seuil. Placer le spot du capteur devant la cible à détecter. Appuyer sur le bouton CONFIGURER tant que la LED d'état PRÊT ne se rallume (3 s) ou transmettre la commande IO-Link Standard « Teach Dynamic (76) ». Pour terminer la saisie dynamique, appuyer sur le bouton CONFIGURER ou transmettre la commande IO-Link Standard « Teach Dynamic (76) ».

Le capteur fonctionne par alternance d'émissions de couleur rouge, verte et bleue.

Si la saisie a réussi, le capteur revient au mode de fonctionnement normal. Si la saisie a échoué à cause d'un contraste insuffisant, la LED d'état PRÊT clignote de manière rapide.

En appuyant sur le bouton ou en utilisant la commande IO-Link Standard « Teach Cancel (79) », le capteur revient à la configuration précédente.

LES MODES D'APPRENTISSAGES ET LEURS FONCTIONS

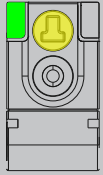
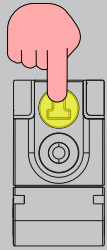
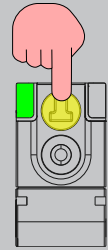
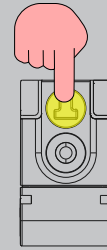
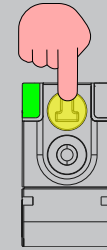
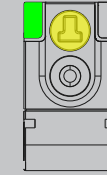
| | Appuyer pendant au moins... | 1s | 3s | 6s | 20s | Relâchement de la |
|---------------------------|---|--|--|--|--|---|
| Groupe fonctionnel | Inactif | Teach statique | Teach dynamique | Sélection C/S (commutation) | Restaurer la configuration d'usine | Inactif |
| Feedback visible |  |  |  |  |  |  |
| | LED verte allumée | LED verte éteinte | LED verte allumée | LED verte éteinte | LED verte allumée | LED verte allumée |

OÙ TROUVER LE NOM DU MODÈLE DE VOTRE PRODUIT

PARAMÈTRES IO-LINK

Pour télécharger les paramètres IO-Link, cliquer sur le code QR suivant ou le scanner.

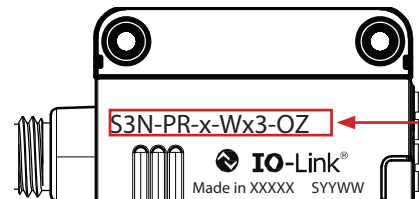

Sur le produit

FONCTIONS DU FIL BLANC (BROCHE 2)

La broche 2 est configurée par défaut comme sortie push-pull. Sa configuration est définie par le paramètre IO-Link « Output type (180) - subidx2 ». Si elle est configurée comme ENTRÉE, la fonction d'entrée peut être configurée via la commande « Input Function Configuration (91) ». Les fonctions disponibles sont : À DISTANCE, L/D et ACTIVATION RETARD. Lorsque la broche 2 est configurée comme entrée et une fonction d'entrée lui est attribuée, cette dernière écrase le paramètre IO-Link correspondant. Par exemple, si la broche 2 est configurée comme entrée d'activation du retard, le paramètre IO-Link « Delay mode (72 - subidx 1) » copiera toujours l'état de la broche 2.

ENTRÉE CLAIR/SOMBRE

En mode clair « LIGHT », la sortie est active avec repères clairs sur arrière-plans foncés.

En mode sombre « DARK », la sortie est active avec repères foncés sur arrière-plans clairs.

Le raccordement du fil clair/sombre « DARK/LIGHT » à Vcc configure le mode clair « LIGHT ». S'il est connecté ou non connecté, il définit le mode sombre « DARK ».

| SOMBRE/CLAIR | Mode |
|--------------|---------------|
| +Vcc | CLAIR (LIGHT) |
| 0 V | SOMBRE (DARK) |

ENTRÉE À DISTANCE

Le signal À DISTANCE peut remplir des fonctions de saisie sans utiliser le bouton CONFIGURER. Sélectionner la broche 2 ou 5 via IO-Link. Le fil À DISTANCE branché à +Vcc correspond à l'appui sur le bouton CONFIGURER. S'il est connecté à la terre « GND » ou non connecté, il correspond à aucun appui sur le bouton CONFIGURER.

| À DISTANCE | Bouton CONFIGURER |
|------------|-------------------|
| 0 V | Non enfoncé |
| +Vcc | Enfoncé |

La durée du raccordement du fil À DISTANCE à +Vcc définit le type de saisie :

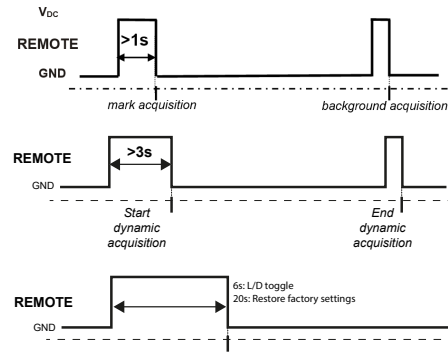

ENTRÉE ACTIVATION RETARD OFF

Le RETARD configuré via IO-Link prolonge la durée minimale de la sortie active, en permettant aux systèmes d'interfaçage plus lents de détecter des impulsions plus courtes. La valeur de retard est définie par le paramètre IO-Link « Delay Settings (72) - subidx 2 ». La valeur par défaut est 20 ms.

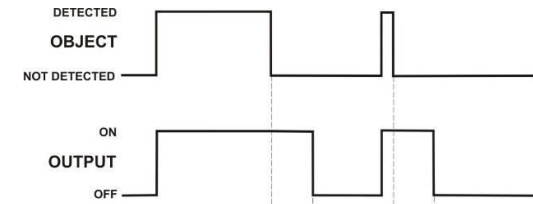

Activation retard

Connecter le signal de retard (fil blanc) à l'alimentation.

Désactivation retard

Connecter le signal de retard (fil blanc) à 0V ou le laisser déconnecté.

| ENTRÉE RETARD | Mode de retard |
|---------------|------------------|
| 0 V | Aucun retard |
| +Vcc | Retard désactivé |

Sur l'étiquette de l'emballage

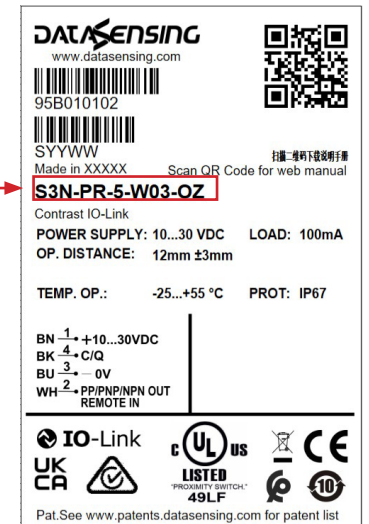

La liste des brevets est consultable sur le site www.patents.datasensing.com.

Ce produit est protégé par un ou plusieurs brevets parmi les suivants :

Brevets d'utilité : IT102015000057325, IT102017000151097,

US10823878, US11146425, US11163090.

©2023 Datasensing S.r.l.

• Tous droits réservés • Sans limiter les droits d'auteur, aucune partie de cette documentation ne peut être reproduite, stockée ou introduite dans un système de recherche, ni transmise sous quelque forme ou par quelque moyen que ce soit, ni à quelque fin que ce soit, sans l'autorisation écrite expresse de Datasensing S.r.l. • Datasensing et le logo Datasensing sont des marques déposées de Datasensing S.r.l.



DIMENSIONI

NOTA: I valori "A" e "B" nel disegno seguente sono indicati nella tabella "Interassi ottici".

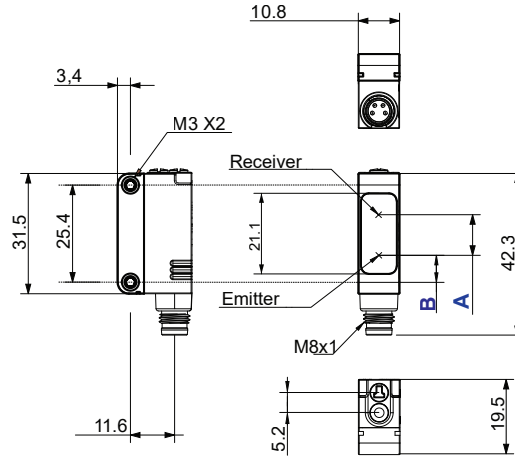

| Interassi Ottici | | |
|------------------|-----|-----|
| Versione | A | B |
| S3N-PR-X-Wx3 | 7,2 | 7,5 |

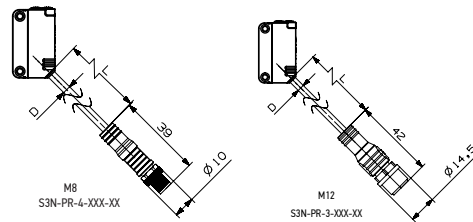

| Versione | Tipo pig-tail | L [mm] | P [mm] |
|-----------------|---------------|--------|--------|
| S3N-PR-3-XXX-XX | M12 - 4p | 250 | 3,7 |
| S3N-PR-4-XXX-XX | M8 - 4p | 200 | 3,7 |

Datasensing S.r.l.
 Strada S. Caterina 235 - 41122 Modena - Italia
 Tel. +39 059 420411 - Fax +39 059 253973
 web: www.datasensing.com
 email: info@datasensing.com

S3N-PR...Wx3
SENSORE DI CONTRASTO

Precauzioni di sicurezza

Leggere le precauzioni per tutti i modelli sul sito <http://www.datasensing.com>.

- ATTENZIONE:** Questo prodotto non è stato progettato o classificato per garantire la sicurezza personale, né direttamente né indirettamente. Non utilizzarlo per tali scopi.
- ATTENZIONE:** Non superare la tensione nominale. Rischio di guasti e incendi.
- AVVERTENZA:** Non utilizzare questo prodotto al di sopra del suo grado di protezione IP. La mancata osservanza di tale precauzione potrebbe portare ad un danneggiamento dei componenti.
- AVVERTENZA:** I modelli CC non devono mai essere utilizzati con l'alimentazione di rete CA. In caso contrario, potrebbero verificarsi esplosioni o altri danni.
- AVVERTENZA:** Non smontare il prodotto. L'esposizione alla sorgente luminosa incorporata può recare danni a occhi e pelle. Non smontarlo mai.

CONTROLLI GENERALI

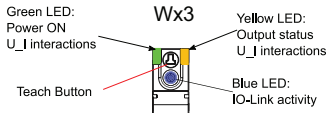

Pulsante Teach (Wx3)

Esegue tutte le interazioni dell'interfaccia utente.

LED uscita

Il LED giallo indica lo stato dell'uscita.

LED di accensione (Wx3)

Il LED verde indica che il sensore è in funzione.

LED Attività IO-Link (Wx3)

La luce blu è accesa durante lo scambio dati IO-Link.

COLLEGAMENTI

Wx3

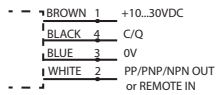

CONNETTORE M8



CONNETTORE M12

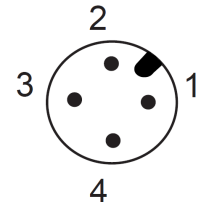

INSTALLAZIONE

Il sensore può essere posizionato tramite i due fori filettati (M3) utilizzando due viti (M3x12 o più lunghe, o vite passante M2,5 + dadi) con le relative rondelle. La coppia di serraggio massima è 0,5Nm.

Sono disponibili diverse staffe per facilitare il posizionamento del sensore (fare riferimento anche agli accessori elencati nel catalogo).

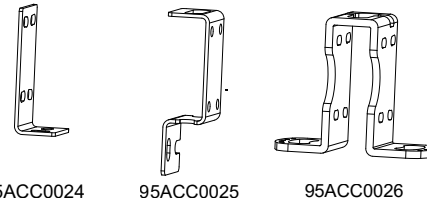

DATI TECNICI

| 3N-PR-W03-OZ | |
|----------------------------------|--|
| Tensione di alimentazione: | 10-30 Vcc; protezione inversione polarità |
| Tensione di ripple: | p-p 10% max. |
| Assorbimento di corrente: | ≤40mA (≤20mA a 24V) |
| Uscita: | W03: IO-Link (Pin 4)+ I/O configurabile (Pin 2) |
| Corrente di uscita: | 100 mA max., protezione contro il cortocircuito |
| Tensione di saturazione: | 1 V max. |
| Tempo di risposta: | 16us/10,5us selezionabile risposta min. alla max. frequenza di commutazione: 8us tramite parametrizzazione IO-Link |
| Jitter: | 8us/4us (default: 4us) |
| Frequenza max. di commutazione: | 30kHz/60kHz selezionabile (default: 60kHz) tramite parametrizzazione IO-Link |
| Indicatori: | Giallo: stato dell'uscita Verde: accensione Blu: Attività IO-Link |
| Impostazione: | Pulsante Teach o IO-Link |
| Temperatura d'esercizio: | -25°C...55°C (senza condensa) |
| Temperatura di immagazzinamento: | -40 ... +70 °C |
| Distanza operativa: | 12 mm |
| Profondità di campo: | ± 3 mm |
| Tipo di emissione: | blu (460nm) / verde (525nm) / rosso (633nm) IEC 62471 GRUPPO DI RISCHIO ESENTE (RGD) |
| Reiezione alla luce ambiente: | Secondo 60947-5-2 |
| Vibrazioni: | ampiezza 0,5 mm, frequenza 10 ... 55 Hz, per ogni asse (EN60068-2-6) |
| Resistenza agli urti: | 11 ms (30 G) 6 shock per ogni asse (EN60068-2-27) |
| Contenitore: | Corpo: Tecnopolimero caricato a vetro Indicatori: TPE Attuatori: POM |
| Lenti: | PMMA |
| Classe di protezione: | IP67 |
| Connessioni: | Sul cavo S3N-PR-3-xxxxx con connettore M12 a 4 poli Sul cavo S3N-PR-4-xxxxx con connettore M8 a 4 poli Su S3N-PR-5-xxxxx: connettore M8 a 4 poli |
| Peso: | 50 g max. versioni a cavo / 10 g. versioni a connettore |

IMPOSTAZIONI WX3

S3N-PR-X-Wx3-XX

ACQUISIZIONE TACCA-SFONDO

Posizionare la tacca davanti allo spot luminoso del sensore e premere il pulsante IMPOSTA per 1s fino allo spegnimento del LED verde di stato PRONTO, oppure utilizzare il comando standard IO-Link "Teach Static (75)". Il sensore rileva la tacca alternando emissioni di colore rosse, verdi e blu. Evitare di muovere la tacca durante questa fase.

Posizionare lo sfondo davanti allo spot luminoso del sensore e premere il tasto IMPOSTA nuovamente o utilizzare il comando IO-Link Standard "Teach Static (75)". Il sensore rileva la tacca alternando emissioni di colore rosse, verdi e blu. Evitare di muovere lo sfondo durante questa fase.

Se l'acquisizione è riuscita, il sensore torna al funzionamento normale. Se non è riuscita a causa di un contrasto insufficiente, il LED di stato PRONTO lampeggia rapidamente.

Premendo il pulsante o utilizzando il comando IO-Link Standard "Teach Cancel (79)" si riporta il sensore all'impostazione precedente.

ACQUISIZIONE DINAMICA

Utilizzare l'acquisizione dinamica per acquisire le tacche in movimento. Il sensore rileva il contrasto tra la tacca e lo sfondo in movimento e imposta automaticamente il valore di soglia. Posizionare lo spot del sensore davanti l'obiettivo da rilevare. Premere il tasto IMPOSTA fino a quando il LED di stato PRONTO si accende di nuovo (3 s) o inviare il comando IO-Link Standard "Teach Dynamic (76)". Per terminare l'acquisizione dinamica premere il tasto IMPOSTA o inviare il comando IO-Link Standard "Teach Dynamic (76)".

Il sensore funziona alternando emissioni di colore rosso, verde e blu.

Se l'acquisizione è riuscita, il sensore torna al funzionamento normale. Se non è riuscita a causa di un contrasto insufficiente, il LED di stato PRONTO lampeggia rapidamente.

Premendo il pulsante o utilizzando il comando IO-Link Standard "Teach Cancel (79)" si riporta il sensore all'impostazione precedente.

FUNZIONI MODALITÀ APPRENDIMENTO

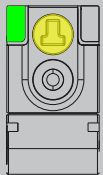
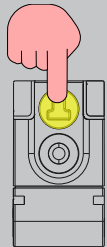
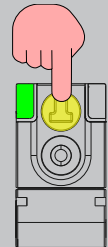
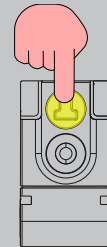
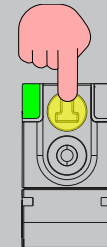
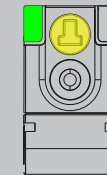
| | Premere per almeno... | 1s | 3s | 6s | 20s | Rilascio pulsante |
|--------------------------|---|--|--|--|--|---|
| Gruppo funzionale | Inattivo | Teach statico | Teach dinamico | Selezione L/B (Commutazione) | Ripristinare le impostazioni di fabbrica | Inattivo |
| Feedback visivo |  LED verde acceso |  LED verde spento |  LED verde acceso |  LED verde spento |  LED verde acceso |  LED verde acceso |

PARAMETRI IO-LINK

Per scaricare i parametri IO-Link, cliccare o scansionare il seguente codice QR.



FUNZIONI DEL FILO BIANCO (PIN2)

Il pin2 è configurato di default come uscita push-pull. La sua configurazione è definita dal parametro IO-Link "Output type (180) - subidx2".

Se è configurato come INGRESSO, la funzione di ingresso può essere imposta tramite il comando "Input Function Configuration (91)".

Le funzioni disponibili sono: REMOTO, L/D e ABILITAZIONE RITARDO.

Quando il pin2 è configurato come ingresso e gli viene assegnata una funzione di ingresso, quest'ultima sovrascrive il parametro IO-Link corrispondente. Ad esempio, se il pin2 è configurato come ingresso di abilitazione del ritardo, il parametro IO-Link "Delay mode (72 - subidx 1)" copierà sempre lo stato del pin2.

INGRESSO LUCE/BUIO

In modalità luce "LIGHT", l'uscita è attiva con tacche chiare su sfondi scuri.

In modalità buio "DARK", l'uscita è attiva con tacche scure su sfondi chiari.

Il collegamento del filo buio/luce "DARK/LIGHT" a Vcc imposta la modalità luce "LIGHT". Se collegato o non collegato, imposta la modalità buio "DARK".

| BUIO/LUCE | Modalità |
|-----------|--------------|
| +Vcc | LUCE (LIGHT) |
| 0 V | BUIO (DARK) |

INGRESSO REMOTO

Il segnale REMOTO può svolgere funzioni di acquisizione senza l'uso del pulsante IMPOSTA. Selezionare il pin 2 o 5 tramite IO-Link. Il filo REMOTO se collegato a +Vcc equivale alla pressione del pulsante IMPOSTA. Se collegato a massa "GND" o non collegato, equivale a non premere il pulsante IMPOSTA.

| REMOTO | Pulsante IMPOSTA |
|--------|------------------|
| 0 V | Non premuto |
| +Vcc | Premuto |

La durata del collegamento del filo REMOTO a +Vcc determina il tipo di acquisizione:

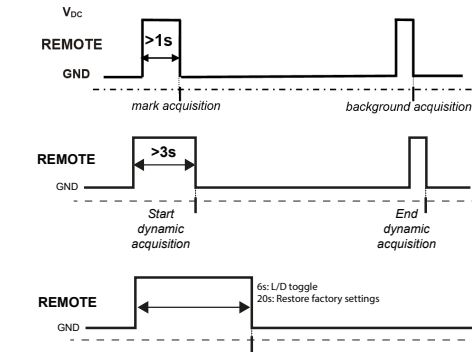

INGRESSO ABILITAZIONE RITARDO OFF

Il RITARDO impostato tramite IO-Link prolunga la durata minima dell'uscita attiva, consentendo ai sistemi di interfacciamento più lenti di rilevare impulsi più brevi. Il valore di ritardo è impostato dal parametro IO-Link "Delay Settings (72) - subidx 2". Il valore di default è 20 ms.

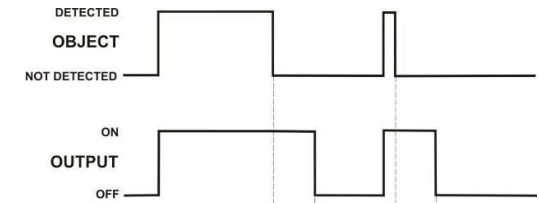

Attivazione ritardo

Collegare il segnale di ritardo (filo bianco) all'alimentazione.

Disattivazione ritardo

Collegare il segnale di ritardo (filo bianco) a 0V o lasciarlo scollegato.

| INGRESSO RITARDO | Modalità di ritardo |
|------------------|---------------------|
| 0 V | Nessun ritardo |
| +Vcc | Ritardo disattivato |

Sull'etichetta della busta



DOVE TROVARE IL NOME DEL MODELLO DEL VOSTRO PRODOTTO

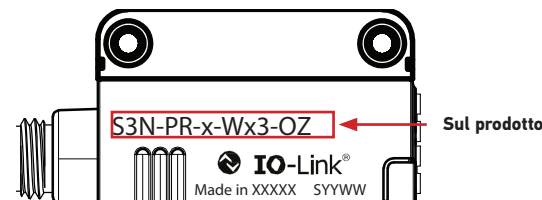

L'elenco dei brevetti è disponibile sul sito www.patents.datasensing.com.

Questo prodotto è coperto da uno o più dei seguenti brevetti:

Brevetti di utilità: IT102015000057325, IT102017000151097, US10823878, US11146425, US11163090.

©2023 Datasensing S.r.l.

• Tutti i diritti riservati • Senza con ciò limitare i diritti coperti dal copyright, nessuna parte della presente documentazione può essere riprodotta, memorizzata o introdotta in un sistema di recupero o trasmessa in qualsiasi forma o con qualsiasi mezzo, o per qualsiasi scopo, senza l'espresso consenso scritto di Datasensing S.r.l. • Datasensing e il logo Datasensing sono marchi di Datasensing S.r.l.



尺寸

注释：下图中的“A”和“B”值在“光轴间距”表中表示。

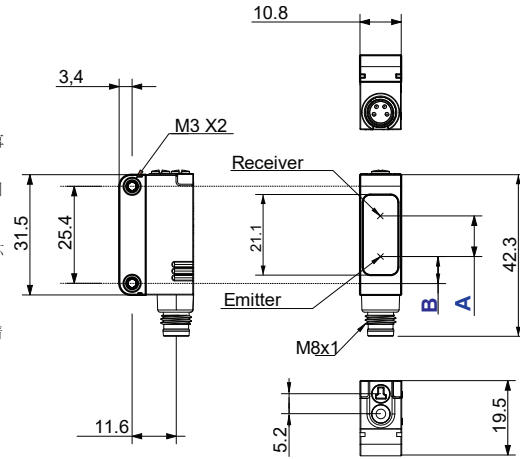

| 光轴间距 | | |
|--------------|-----|-----|
| 版本 | A | B |
| S3N-PR-X-Wx3 | 7.2 | 7.5 |

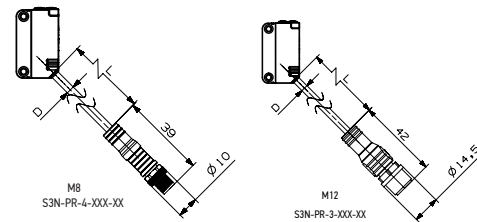

| 版本 | 尾纤型 | L [mm] | D [mm] |
|-----------------|----------|--------|--------|
| S3N-PR-3-XXX-XX | M12 - 4p | 250 | 3.7 |
| S3N-PR-4-XXX-XX | M8 - 4p | 200 | 3.7 |

Datasensing S.r.l.
Strada S. Caterina 235 - 41122 Modena - Italy
电话 +39 059 420411 - 传真 +39 059 253973
网站: www.datasensing.com
电子邮箱: info@datasensing.com

S3N-PR... Wx3

对比度传感器

安全注意事项

请访问 <http://www.datasensing.com> 阅读所有型号的注意事项。

- 警告：本产品的设计或评级不是为了直接或间接确保人身安全。请勿将其用于此类目的。
- 警告：请勿超出额定电压使用。否则有可能发生故障甚至火灾。
- 小心：请勿在超过其 IP 保护等级的情况下使用该产品。否则可能会损坏其零部件。
- 小心：直流型号不得与交流主电源一起使用。否则可能导致爆炸或其他损害。
- 小心：请勿拆解本产品。否则可能会使人员暴露于内置光源，进而损害眼睛和皮肤。任何情况下都不得将其拆解。

一般控件

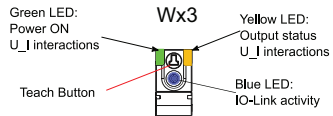

示教按钮 (Wx3)
执行所有用户界面交互操作。

输出 LED
黄色 LED 指示输出状态。

开机 LED (Wx3)
绿色 LED 表示传感器正在运行。

IO-Link 活动 LED (Wx3)
在 IO-Link 数据交换期间，蓝灯亮起。

连接

Wx3

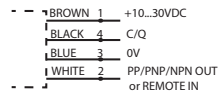

M8 连接器

M12 连接器

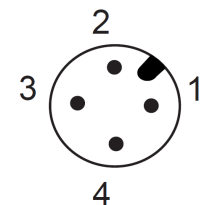

安装

可以通过两个螺纹孔 (M3)，使用两个螺钉 (M3x12 或更长，或 M2.5 通孔螺钉 + 螺母) 和对应垫圈对传感器进行定位。最大拧紧扭矩为 0.5 Nm。
各种支架可用于简化传感器定位 (也请参阅目录中列出的附件)。

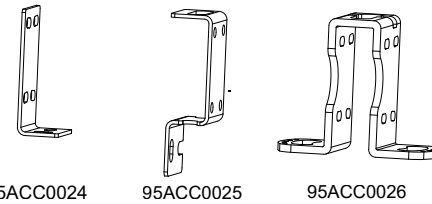

技术数据

| 3N-PR-W03-OZ | |
|--------------|---|
| 电源: | 10-30 Vdc; 反极性保护 |
| 纹波: | 最大 p-p 10% |
| 电流消耗: | ≤40mA (≤20mA 时 24V) |
| 输出: | W03: IO-Link (引脚 4) + 可配置的 I/O (引脚 2) |
| 输出电流: | 最大 100 mA 短路保护 |
| 饱和电压: | 最大 1 V。 |
| 响应时间: | 16µs/10.5µs 可选择 最大 f _{sw} 下的最小响应: 8µs 通过 IO-Link 参数化 |
| 抖动: | 8µs/4µs (默认: 4µs) |
| 最大开关频率: | 30kHz/60kHz 可选择 (默认: 60kHz) 通过 IO-Link 参数化 |
| 指示灯: | 黄色: 输出状态 绿色: 开机 蓝色: IO-Link 活动 |
| 设置: | 示教按钮或 IO-Link |
| 工作温度: | -25° C...55° C (无冷凝) |
| 存储温度: | -40 ... +70 ° C |
| 工作距离: | 12毫米 |
| 景深: | ± 3 mm |
| 发射类型: | 蓝色 (460nm)/绿色 (525nm)/红色 (633nm) EC 62471 无风险组 (RGO) |
| 环境光抑制: | 符合 60947-5-2 |
| 振动: | 每个轴 0.5 mm 振幅, 10 ... 55 Hz 频率 (EN60068-2-6) |
| 抗冲击性: | 每个轴 11 ms (30 G) 6 次冲击 (EN60068-2-27) |
| 外壳: | 主体: 玻璃填充技术聚合物 指示灯: TPE 执行器: POM |
| 镜头: | PMMA |
| 防护等级: | IP67 |
| 连接: | 在带有 M12 4 针连接器的 S3N-PR-3-xxxxx 电缆上 在带有 M8 4 针连接器的 S3N-PR-4-xxxxx 电缆上 在 S3N-PR-5-xxxxx 上, M8 连接器 4 极 |
| 重量: | 电缆版本最大 50 g/ 连接器版本 10 g |

WX3 设置

S3N-PR-X-Wx3-XX ⓘ

标记-背景采集

将标记置于传感器光斑前部，然后按下 SET 按钮 1 秒，直到绿色 READY LED 熄灭，或使用 IO-Link 标准命令“Teach Static (75)”。传感器交替发射红绿蓝光来检测标记。在此阶段避免标记移动。
将背景放在传感器光斑的前面，然后再次按下 SET 按钮或使用 IO-Link 标准命令“Teach Static (75)”。传感器交替发射红绿蓝光来检测标记。在此阶段避免背景移动。
如果采集成功，传感器返回正常工作状态。如果由于对比度不足而失败，则 READY LED 将快速闪烁。
通过按下按钮或使用 IO-Link 标准命令“Teach Cancel (79)”，传感器可返回到之前的设置。

动态采集

使用动态采集来采集移动标记传感器检测标记和移动背景之间的对比度，并自动设置阈值。将传感器光斑放置要在检测的目标之前。按下 SET 按钮，直到 READY LED 再次亮起（3 秒）或发送 IO-Link 标准命令“Teach Dynamic (76)”。要结束动态采集，请按下 SET 按钮或发送 IO-Link 标准命令“Teach Dynamic (76)”。
传感器功能交替发出红色，绿色和蓝色发射光。
如果采集成功，传感器返回正常工作状态。如果由于对比度不足而失败，则 READY LED 将快速闪烁。
通过按下按钮或使用 IO-Link 标准命令“Teach Cancel (79)”，传感器可返回到之前的设置。

白线（引脚 2）功能

引脚 2 默认配置为推挽式输出。其配置由 IO-Link 参数“Output type (180) - subidx2”定义。
如果配置为 INPUT，则输入功能可通过“Input Function Configuration (91)”进行设置。
可用功能包为：REMOTE、L/D 和 DELAY ENABLE。
当引脚 2 配置为输入并为其分配输入功能时，输入功能将覆盖相应的 IO-Link 参数。例如，如果引脚 2 配置为延迟启用输入，则 IO-Link 参数“Delay mode (72 - subidx 1)”将始终复制引脚 2 的状态。

亮/暗输入

在亮模式下，输出在暗背景亮标记下激活。
在暗模式下，输出在亮背景暗标记下激活。
暗/亮线与 Vcc 连接将设置为亮模式。如果连接到 0V 或未连接，则设置为暗模式。

| 暗/亮 | 模式 |
|------|----|
| +Vcc | 亮 |
| 0V | 暗 |

远程输入

REMOTE 信号无需使用 SET 按钮即可执行采集功能。通过 IO-Link 选择引脚 2 或 5。REMOTE 线连接到 +Vcc 等同于按下 SET 按钮。如果连接到 GND 或未连接，则等同于未按下 SET 按钮。

| 远程 | SET 按钮 |
|------|--------|
| 0V | 未按下 |
| +Vcc | 按下 |

REMOTE 线与 +Vcc 的连接持续时间决定了采集类型：

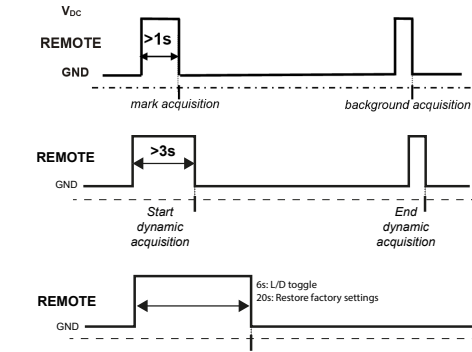

延迟关闭启用输入

通过 IO-Link 设置的延迟扩展了有效输出的最小持续时间，允许实现更慢的系统连接，从而检测更短的脉冲。延迟值由 IO-Link 参数“Delay Settings (72) - subidx 2”设置。默认值为 20ms。

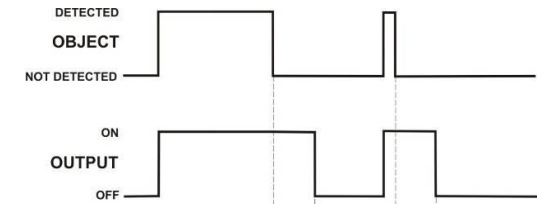

延迟激活
将延迟信号（白线）连接到电源。
延迟停用
将延迟信号（白线）连接到 0V 或保持断开状态。

| 延迟输入 | 延迟模式 |
|------|------|
| 0V | 无延迟 |
| +Vcc | 延迟关闭 |

示教模式功能

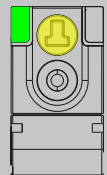
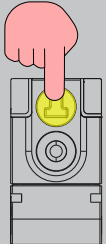
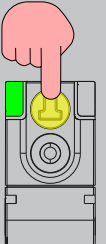
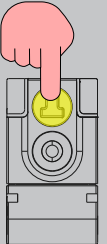
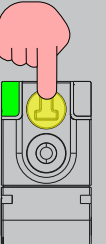
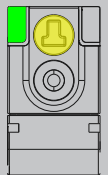
| | 按住... | 1s | 3s | 6s | 20s | 按钮释放 |
|------|--|--|--|--|--|--|
| 功能 | 闲置 | 静态示教 | 动态示教 | 亮/暗选择（切换） | 恢复出厂设置 | 闲置 |
| 视觉反馈 |  绿色 LED 亮 |  绿色 LED 灭 |  绿色 LED 亮 |  绿色 LED 灭 |  绿色 LED 亮 |  绿色 LED 亮 |

哪里可以找到产品型号名称

IO-LINK 参数

要下载 IO-Link 参数，请点击或扫描下面的二维码。

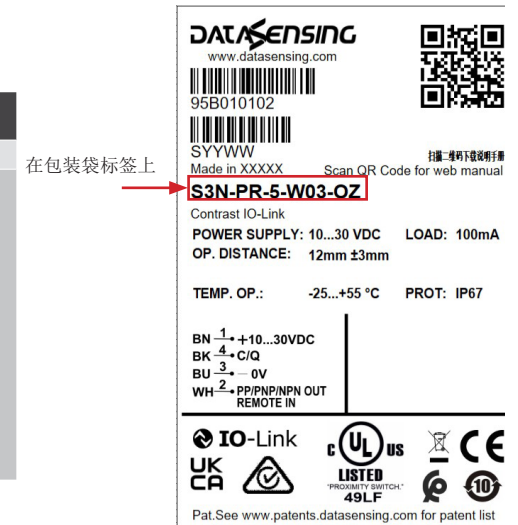
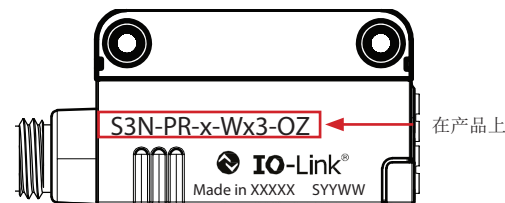

在包装袋标签上

有关专利列表，请参见 www.patents.datasensing.com。

该产品受以下一项或多项专利保护：
实用专利：IT102015000057325, IT102017000151097, US10823878, US11146425, US11163090。

©2023 Datasensing S. r. l.

保留所有权利。在不限制版权所有权，或未经 Datasensing S. r. l. 书面许可的情况下，不得对此文档的任何一部分进行复制、存储或将其引入检索系统，不得以任何形式、通过任何方法对此文档进行传播、复制、分发或用于任何目的。Datasensing 和 Datasensing 标识是 Datasensing S. r. l. 的商标。